

# Operation of Radio Frequency Identification Technology to Control Cattle Movements

Tigana Mandimby, Germain Bernard, Edmond Herinantenaina, Diamondra Razaivaovololoniaina, Elisé Raveloson, Zely Randriamanatany, Jules Bosco Bezaka

University of Antananarivo, Madagascar

Received: 03 Jul 2024; Received in revised form: 25 Jul 2024; Accepted: 29 Jul 2024; Available online: 15 Aug 2024

**Abstract**— *Cattle theft is a critical social problem in Madagascar. Tools for traceability management are still not effective up to the present time. This research aims to contribute in the fight against this scourge. It is based on the implementation of a mobile identification system and the development of a software called "Omby" which purpose is to make systematic controls of cattle movements. RFID and ICTs technology is adopted for the traceability system. The application is written in C++ language and is developed with the programming and interface creation tool QTcreator 1.2.1. An Arduino Mega 2560 card is used to make mobile control system. This application allows to scan and generate the cattle ID number by referring to an existing database. The system created by this new technology facilitates the fight against cattle theft as a result of real-time availability of the oxen localization as well as information regarding them. It could be also used to improve animal health.*

**Keywords**— *radio frequency, Security, tags, animal, Arduino*

## I. INTRODUCTION

Since the dawn of time, it has always been a concern for the human to identify, locate and track objects by using first visual identification then electronic equipment. Several practical systems have been used over the years, unique marks have been placed on objects, and recognition devices could identify these codes and by the same way the object on which they are glued. From there was born the barcode system which, for several years, has allowed the dream for objects identification. However, barcodes present several shortcomings, including the lack of data storage, the need to scan, etc. These deficits have continually pushed man to look for a better solution to overcome this lack, and that's why was born very recently RFID technology which apparently solved the problems of identification, location, tracking and data analysis.

In this work, the exploitation of RFID technology will be addressed to control the herds movement. A number of questions related to issues that cross industries, science and everyday life will be answered, including:

- The emergence of new technology as part of automatic identification systems based on radio frequency calls to

its exploration to see its potential, its limits and its analysis in order to assess how it could apply to applications in the domain of identification, health, logistics, equipment maintenance and security;

- Available information on RFID technology remains poorly consistent, complex and sometimes difficult to understand to people to date, making it difficult to make decision for its use;
- Given the exponential growth in the number of items in all domains, there are problems related to identification, tracking, traceability and location. These concerns require a new way of doing, a new technology that will be able to meet these requirements;
- Solving problems related to security and access control for different facilities in high risk areas by the way of traceability, intervention improvement, history tracking and maintenance of equipment;
- Establishing a personal link with the product to control the source and the manufacturing for safety reasons or to integrate it more intimately in individual everyday life by creating a greater interaction between the chain and the product.

Regarding these problems, the objective of this work is to produce a reference document on radio frequency identification RFID technology, analyze its potential and propose an implementation strategy, mostly in the domain of equipment maintenance and safety through application of traceability systems.

## II. METHODOLOGY

### Beef industry in Madagascar.

Livestock is the second activity after farming (Fig.1). Cattle farming occupies a prominent place in the animal production sector. Estimated at 7.4 million head in 2000, the cattle herd represents a fixed capital of about 200 million US\$ [1].



*Fig.1. The cattle in Madagascar*

This section first highlights the problems of the beef industry in Madagascar

To identify the animal in Madagascar, we use:

the bokin' omby which is identified each year and is issued to each breeders.

the traceability of cattle that is done with marking with red-hot iron since the past or by markings on the ears. This principle was practiced almost in the entire island.

the cattle individual form (FIB) which is issued by the community of provenance before the movement of the animal.

the earring is a codified system of identification set on the cattle left ear to ensure its traceability throughout his life, his displacement and slaughter.

For the movement of cattle, there are "cattle pathways" set by regional order, especially for the bovine in trade (Fig. 2), [2]. The marketing of bovine request professional card valid on the national territory.



*Fig.2. Bovine in trade*

Any standing beef to be exported must be accompanied each of his FIB and also set with earring [2].

Despite all that, problems related to insecurity are stated in rural areas that often occur as bovine theft especially in the provinces of Mahajanga, Toliara and Fianarantsoa.

On average, environ 1.500 oxen heads for every 100,000 inhabitants are stolen each year and among them, one third (323.2 heads) stolen oxen found returned to their owner, [3].

Figure 3 shows the problem of insecurity on the theft of bovine in Madagascar.



<https://www.YouTube.com/watch?v=jZhnMFbAu3Y>

*Fig. 3. Insecurity problem*

The lack of infrastructure and the nonexistence of an export perspective are key marketing issues. For some time, the annual quota of Madagascar of meat for export to the European market was canceled due to lack of slaughterhouses coping with international standards and non-traceability of animals. Table I shows the evolution in quantity in tons of meat.

Table II. Evolution in quantity in tons of meat from the year 1996 to 2001

Année	1996	1997	1998	1999	2000	2001
Quantité (tonnes)	1760	620	74,7	10,9	0,04	0,01

Source: [5]

Thus, despite the identification principle that the Ministry of livestock had done historically, the traceability of livestock is still obsolete.

To address this, the use of radio frequency identification (RFID) technology has been proposed, to facilitate the task of controllers and to fight against any records falsification.

#### A. RFID technology

RFID technology allows to identify an object, follow the path and know features remotely due to a transponder emitting radio waves, attached or incorporated into the object. It also allows reading the labels even without direct line of sight and can cross thin layers of materials (paint, snow, etc.).

Below is the history of this technology and some typical applications.

The origin of RFID technology is obsolete and varied according to the sources. RFID technology according to the approach based on the operation principle, has emerged by the 1920s, then in 1945 a Russian engineer L. Theremin developed a device, [6].

Around the 1940s, the System RFID technology had been used for aircraft recognition. The radars were the reading system which was designed to send a signal questioning transponders placed on the aircraft labels to distinguish allies from enemies. And we can consider that the *System Identity Friend or Foe* (IFF) was the first form of RFID technology use.

Over the years, technology has taken the magnitude, and especially in the 1970s when it was a protected technology and mainly reserved to military use. Developed countries were using this technology for the safety and protection of strategic and sensitive sites (heavy weaponry and nuclear sectors). However, towards the end of the 1970s this technology was used by the private sector, and the first

commercial application was the (identification) traceability of cattle in the European continent.

During the 1980s, technological evolution with the invention of Microsystems using integrated circuits led to the use of passive tags or passive transponder. At that time a wide variety of types of transponders, was born.

The beginning of the 1990s was the time of issues related to standardization and normalization of the RFID equipment (transponders and readers).

Since then, RFID technology is used in several domains of application, passing by the identification, the traceability and the data analysis, [6], [7].

The RFID operating principle is determined by the function of its various components including the base station as main component (Fig. 4) and the transponder (Fig. 5).

a) *base Station* : RFID base station is a main component of the radio frequency part. This module is comprised of encoding and decoding tools to convert binary data into Radio frequency signals, and vice versa, as well as modulation and demodulation tools to transmit the message through a Radio frequency carrier

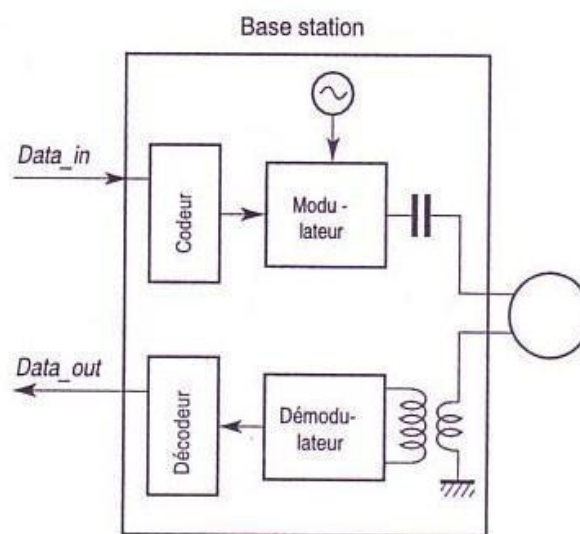
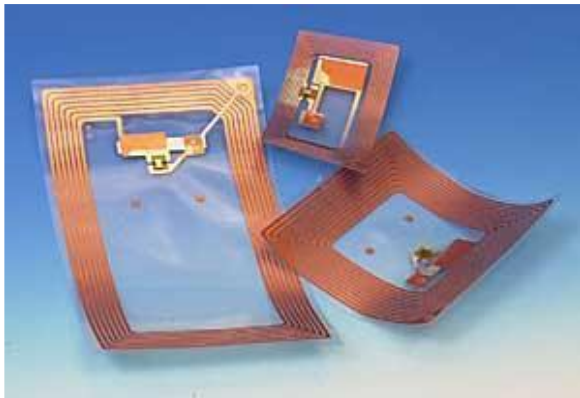

Fig. 4. Base station

b) *transponder RFID*: as we see below the example of these transponders (Fig.5).



(a)



(b)

Fig. 5. Transponder

Following are some examples of these transponders and the figure beside their architecture, [8].

The first category of transponder is the most classic. It consists of simple tags, which the copper antenna is placed in "square" and flat (Fig.5.a). The inner part is the chip that is the heart of the transponder. (In this example, the transponders are contained in transparent plastic films but this is obviously not always the case).

The second type of transponder presented is a range that is a little more expensive and intended for specific uses, (Fig. 5.b). They are here composed of a cylindrical copper coil antenna and are locked in glass capsules. This category of labels is for animal implantation.

The term radio frequency (R.F) refers to the radio wave which spectrum is located between 3 kHz and 300 GHz. This includes the frequencies used by different means of radio communication, including mobile telephony, Wi-Fi or broadcasting, as well as signals intended for other uses such as radar or microwaves. Table II shows the ranges of frequencies for RFID technology.

Table II. Ranges of Frequency of RFID Technology

Fréquence	Distance de lecture	Applications
Systèmes RFID en champ proche		
9 – 135 KHz	quelques cm jusqu'au 50 cm	Les cartes de paiement et passeports électroniques
6.78 MHz	quelques cm jusqu'au 50 cm	Pas beaucoup d'application
13.56 MHz	quelques cm jusqu'au 50 cm	Les cartes intelligentes sans Contact
Systèmes RFID en champ lointain		
433.92 MHz	1 m jusqu'au 30 m dépendant des applications	Les systèmes RFID actifs aux fréquences UHF
860 MHz ~ 960 MHz	≈ 5 m jusqu'au 10 m	Les systèmes RFID passifs aux fréquences UHF
2.45 GHz	1 m jusqu'au 6 m	Les systèmes de passage, Actifs
5.8 GHz	Inférieur à 1 m	Pas encore beaucoup d'exploitation

The transmission of signals in this technology is based on the principle of modulation and demodulation of amplitude and frequency, [8].

### III. RESULTS

Because this technology is used to identify a bovine, so related information need to be stored at any location.

#### A- Information storage

Here is the animal identity (Fig. 6.). This number is a coding for the information to store.



Fig. 6. Information Storage

The code is stored on the RFID chip from its conception if the chip is used in read-only mode which is the most interesting and simple manner.

But for the chip that exists in Madagascar, the user can add on additional information, (fig. 7).



Fig. 7. RFID chip

If the identification is done in a control system at the slaughterhouse, the information storage is in the software "Omby" that matches both the FIB and he "bokin' omby '.

Figure 8 represents the interface of this software. When pressing the button ENTER, the data recording interface appears. Once the boxes of this interface are met the GENERATE clicked to generate and save the information in a text file. The SCAN button allow to scan the identification number, CHECK to compare the recorded data and the scanned data and then the screen 3. Press EXIT to exit this software.

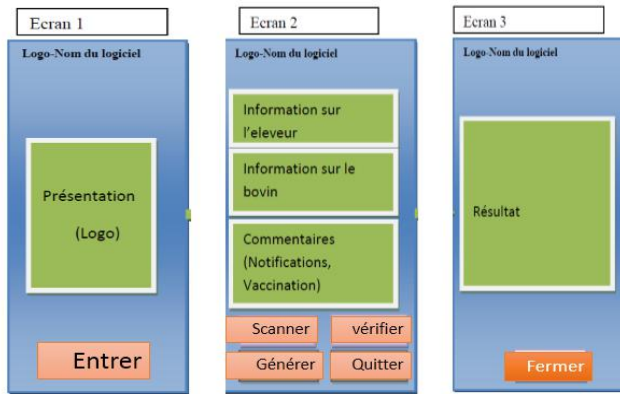

Fig.8. Omby software Interface.

B- Choice of devices to use

A drive is needed to extract the identification code. The Philips MRC522 RFID reader module is used in this work, (Fig.9).

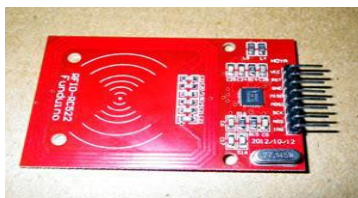

Fig.9. Philips MRC522 RFID reader.

There are two categories of readers: fixed drives and portable players.

The fixe drive is installed on a slaughter chain. In this work, mobile player is formed and model of this drive is the following (Fig.10).



Fig.10. model of the portable player.

Then the verification component is also needed. For fixed device, verification is done by a computer. Cattle data are saved in a microcontroller and is transferred to a software that will ensure the veracity of the data.

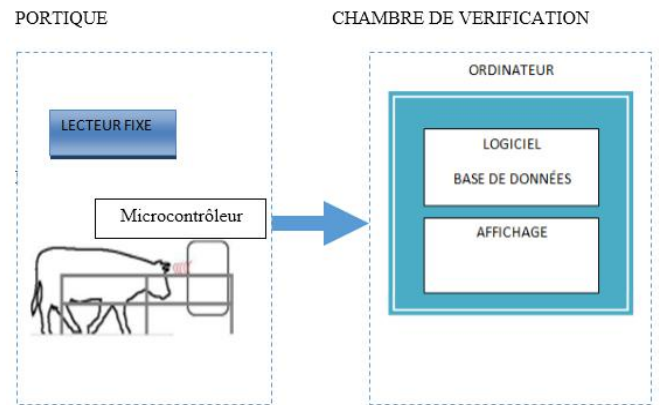

Fig.11. Checking for a fixed reader.

For the mobile device, the checking is made by a microcontroller. The result is displayed on an LCD or TFT screen.

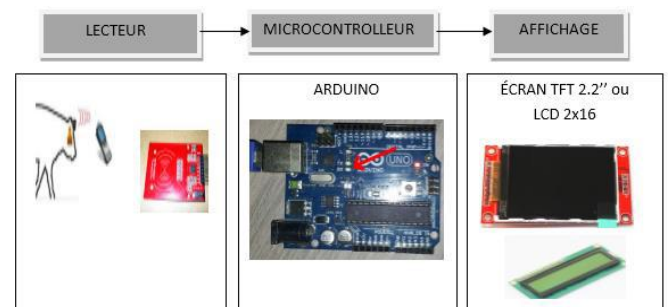

Fig.12. checking for a portable player.

C- Presentation of the mobile identification system

The realization of this system is based on a microcontroller, Arduino driving a RFID chip reader and a 2 x 16 screen LCD. The flowchart in figure 14 shows the general operation of the mobile device. Figure 13 represents the mobile identification system made



Fig.13. portable identification reader.

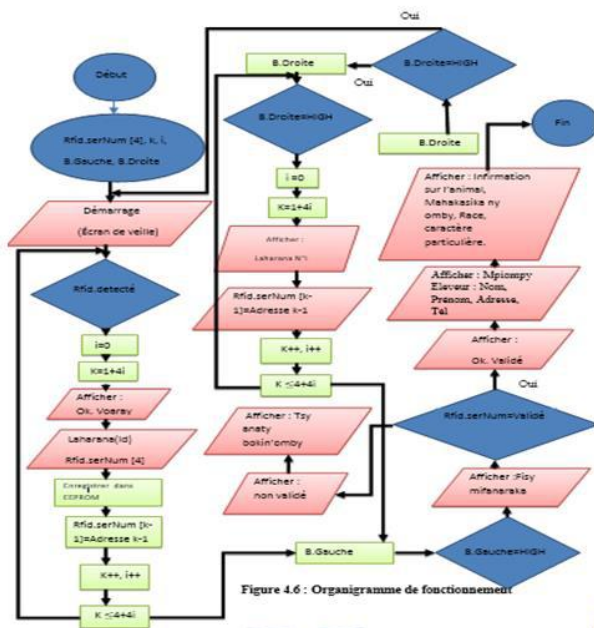

Fig.14. Operation flowchart.

D- Presentation of the software "Omby".

The implementation of the software interface uses the Qt Creator environment and programming language C++, [9], [10].

Figure 15 shows the "Omby software " for information storage and verification that is used in the slaughter station. for the information storage all cages must be completed before generating and saving the information.

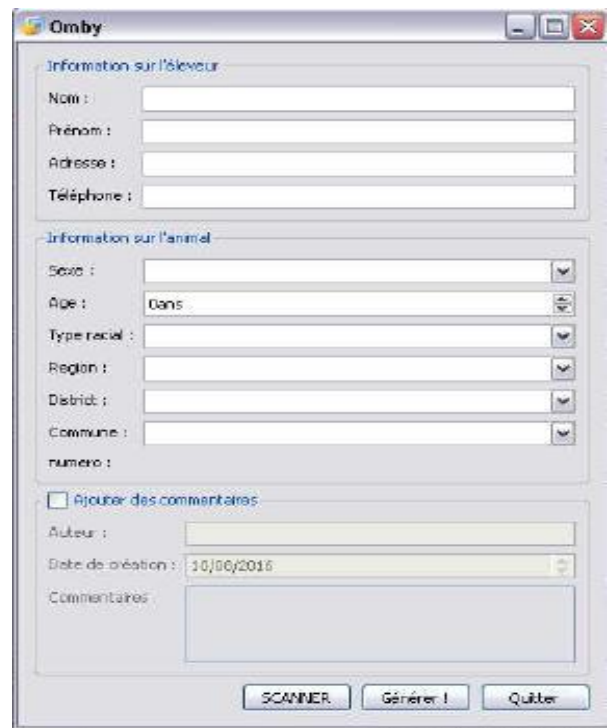

Fig.15. verification software and information storage.

#### IV. DISCUSSION

This technique of animals identification is already used in Europe and America, [11]. Appeared in the early 1990s on the ear loops and cattle passports, the bar code is the first support of traceability. Today, the flash code and RFID solutions are at the forefront in applications. The solutions developed by the company Arsoe of Britain include all of the treatments that make up the livestock custody chain until the national identification database under the Ministry of Agriculture, [12].

To better trace meat and dairy products, and limit the health crises, the European Union now requires an electronic chip for farmed animals. The 'RFID' chip will be mandatory for the goats and sheep by July 2013, [13]. Today electronic identification is used on a daily basis. In animal production, the generalization of RFID has the advantage of avoiding the re-identification and the risk of errors. Other applications are possible in automated weighing, direct notifications of outgoing/incoming animals, operations of contention and selection of lots driven by RFID barriers.

Beyond the animal identification, this work allows to solve specifically some traceability problematic related to bar codes printing, labels edition, the flow management, the containers and logistics management.

Since they can buy earring in which RFID chips are socketed, breeders like to escape tasks that their appear still tedious even if they themselves are significantly reduced in recent years: the entry and registration of animal identification.

##### A- Mobile identification system

This unit with two buttons allows an easy verification, brings comfort of work of a bovine identification and improve current working methods.

This new device fully meets the expectations of farmers involved in the projects.

##### (a) benefits:

- Immediate verification : data is immediately recoverable.
- Automation of the identification verification (commercial operators): this device allows to perform an automatic consistency between the loops and the passport check. Thus, we can reduce tax evasion and theft of bovine.
- Time saving: time to raise the numbers of a batch of 10 weanlings was estimated at more than 20 minutes.
- Security: it is more necessary to catch the ear of the animal to read the issue in its entirety.

- Reliability: readings, no error of seizure to the statement of the numbers.

##### (b) disadvantages:

Reading rate: reading rates, although very good, fixed playback on animals in motion does not yet consistently 100% reading. For flocks, the unread management may be necessary.

The identification by drone system asks a student frequency field

##### B- fixed identification system

Electronic identification with the fixed drive (software development) helps to enhance the internal traceability of the market by automating the cross-check between the ear loops and passports of the animals presented for sale.

At the arrival on the market, animals are saved thanks to the scan of the passports submitted by the breeders. The lots are then set for sale. Software on the market realizes a self-test to check the number of animals of the lot and the well agreement between animal numbers and passports.

Condition of use is that fixed playback requires a contention that is adapted to individual reading of the animals.

##### (a) Strengths:

As all kind of devices, the RFID reader has specific strengths:

- Reliability of control on passport / loops coherence : allow to guarantee the traceability of batches submitted for sale
- Security : it is no more necessary to catch loop to read the number.
- Working comfort : automation of the coherence control and alerts management

It is no longer necessary to search for a number in a list on a form or in a set of passport photocopies

- Reliability : eliminates entry errors

##### (b) general interest:

Interest on the part of the market Manager. "Omby" is a complete interface of information system which fully responded to the expectations of involved slaughterhouses.

##### (c) weak Points and limits:

The control station cannot scan two animals simultaneously. The installation of the drive requires special attention (limited drive choice, need to use a loop to pass arms through to intervene on the animal).

### C- Condition of use

For the mobile control: only one controller Manager can hold the camera. And only the first leader on animal traceability or the designer is authorized to make data update.

For the fixed control: the data must be completed to avoid error, and the computer must be connected to the fixed drive.

### D- System perfection

To perfect the system, using a drone is an option especially to combat the "dahalo. In this case, the mobile identification device must be embedded in the drone. The drone then scans the area that is supposed to be the Lair of the dahalo, to verify the presence of the stolen cattle before starting any operation.

### E- the disturbance by the physical environment

As said in previous chapter, reading of radio frequency labels is disturbed by the presence of metals in their immediate environment. The use of plastic or wood material is a solution to minimize these disturbances.

### F- Health impact

The questions on the impact of radio frequency on health is debated in recent years, particularly for anti-theft porticos and mobile phones.

Passive tags, themselves, present no risk regardless of their number since they are active only when they are in the field of a player. The studies focus on readers and are intended to define the control criteria for their transmitting power, in order to avoid them to create disturbances on health equipment such as pacemakers or on the human body.

## V. CONCLUSION

Traceability of livestock in Madagascar remains obsolete despite the presence of marking, the Ministry of livestock had done historically. Inadequate slaughterhouse standards and the problem to the marketing of cattle are the main reasons for poor performance. Overall, these experiments in the area of the beef industry showed that electronic identification (RFID) allows to simplify work, make information more reliable, enhance the traceability.

Electronic identification is valuable in the Treaty, in relation to automata and herd management software. Mobile identification device manages a lot of information very quickly. Electronic identification allows obvious gains in terms of reliability, safety (tax fraud, fake passport, etc.).

"Omby" is an application on Windows of the still, or more exactly fixed, identification system. It was designed to

demonstrate task and there is a possibility to add other functionality.

This study informs on the development of a RFID cattle ear loop module and also implemented the microcontroller to the APR Arduino, LCD 2 x 16 screen. This material is used thanks to its memory capacity, the number of entry / exit ports, its simplicity, its low price and its availability on the local market. The TFT screen manufactured by Adafruit American society can also be used.

This work also allows to deepen knowledge on electronic devices as well as on computer software development.

Today, the progress of technology is irreversible. For electronic identification, the success is currently reaching the perfection especially in livestock as form of control.

## REFERENCES

- [1] MAEP UPDR-OCEAN CONSULTANT-201 Filière bovins à viande. Doc-juillet 2004
- [2] Décret relatif au recensement, à l'identification, à la circulation et à la commercialisation des bovins, Arrêté Interministériel instituant la carte professionnelle des acheteurs de bovins. Textes Normatifs régissant le secteur élevage, 2012
- [3] Recensement des Communes, Programme Ilo, Cornell Université/FOFIFA/INSTAT, 2001
- [4] STAT-MINAGRI, 2001
- [5] [www.hitechtools.com/RFID](http://www.hitechtools.com/RFID)
- [6] Paulin Ilunga Katamba, conception et stratégie de mise en œuvre, Maitrise, Faculté des sciences et de génie, technologie RFID, Université LAVAL, 2007
- [7] [www-igm.univ-mlv.fr/~dr/XPOSE2007/mmadegar\\_rfid](http://www-igm.univ-mlv.fr/~dr/XPOSE2007/mmadegar_rfid)
- [8] [www-igm.univ-mlv.fr/XPOSEE2007/mmadegar\\_rfid/Christian.weiss@ac-bordeaux.fr](http://www-igm.univ-mlv.fr/XPOSEE2007/mmadegar_rfid/Christian.weiss@ac-bordeaux.fr)
- [9] T. Redarce, N. Ducros, O. Bernard, « langage C/C++ de la syntaxe à la programmation orientée objet », Septembre 2015
- [10] Marc Summerfield, « Advanced Qt Programming: creating great Software with C+ and Qt 4 », 2010.
- [11] Identification et traçabilité des bovins \_ les textes réglementaires.html, 2014
- [12] Traçabilité et RFID% C2% A0-% C2% A0ARSOE Bretagne.html, 2016
- [13] [www.bastamag.net/Tracabilite-alimentaire-la-puce.2016](http://www.bastamag.net/Tracabilite-alimentaire-la-puce.2016)